



Unit 1

14

Cut out and colour. Then listen and play.



CD
1.22

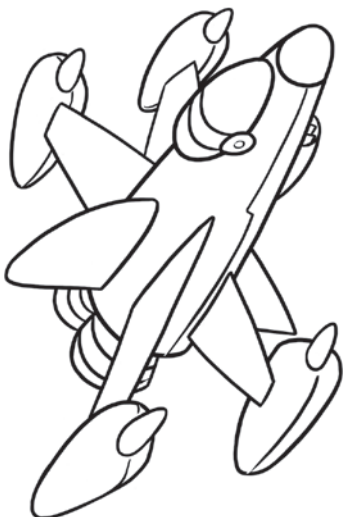
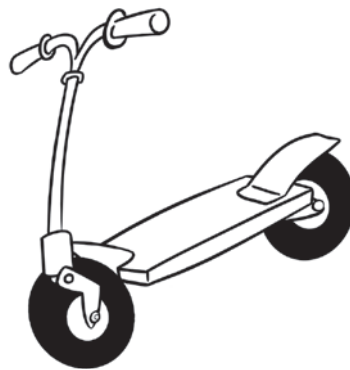
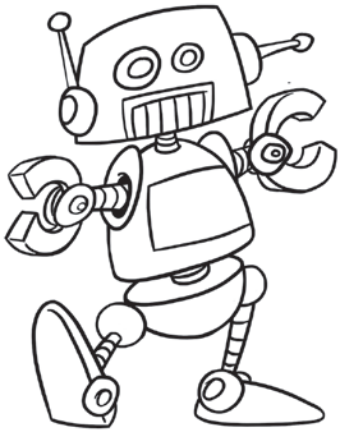
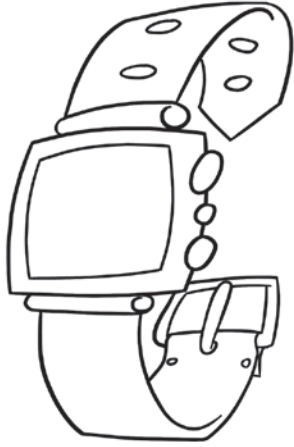

Name:
.....

Name:
.....

Name:
.....

Name:
.....

Name:
.....

Name:
.....

Name:
.....

Name:
.....

Name:
.....



Unit 2

13

Cut out and colour. Then listen and play.



CD
1.38



Name:

.....

Name:

.....

Name:

.....

Name:

.....

Name:

.....

Name:

.....

Name:

.....

Name:

.....



Unit 3

14

Cut out and colour. Then listen and play.



CD 1.51



Name:
.....

Name:
.....

Name:
.....

Name:
.....

Name:
.....

Name:
.....

Name:
.....

Name:
.....

Name:
.....

Name:
.....

Name:
.....

Name:
.....



Unit 4

14

Cut out and colour. Then listen and play.



CD
2.16

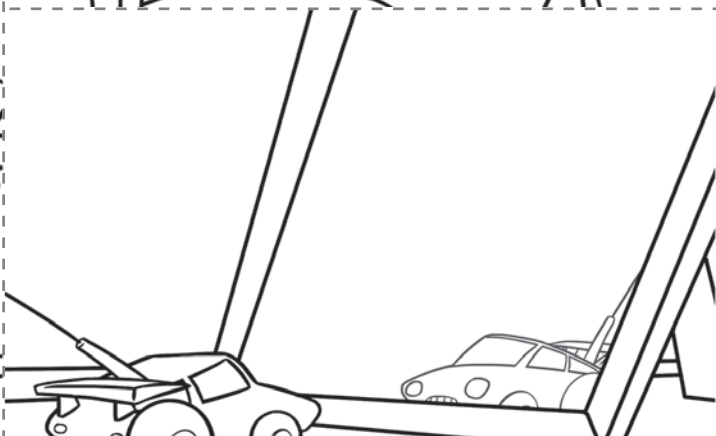
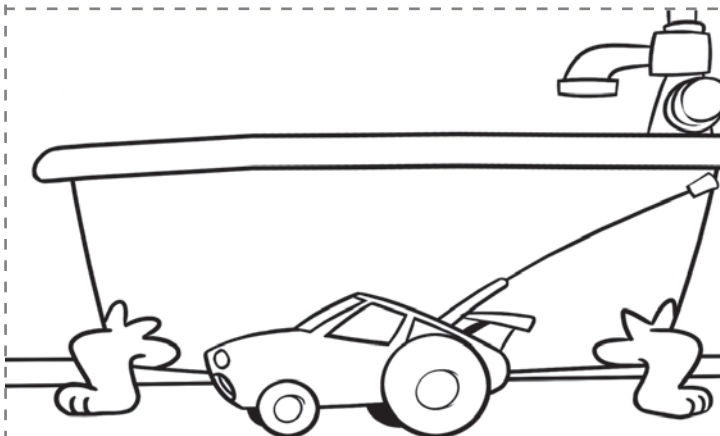
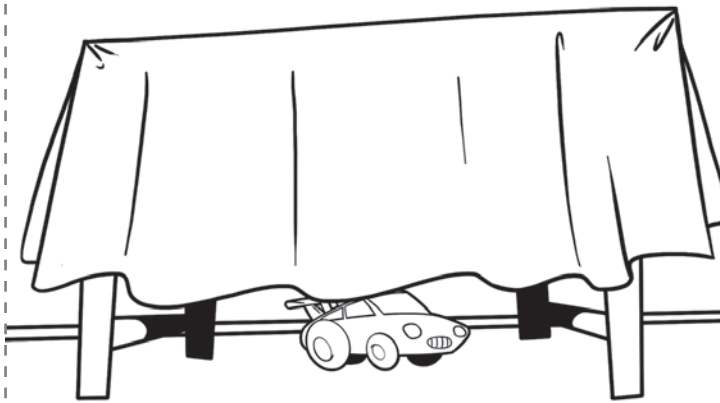
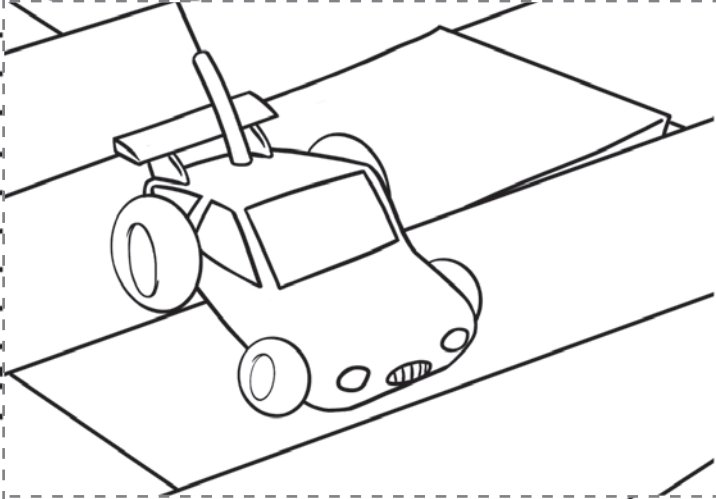
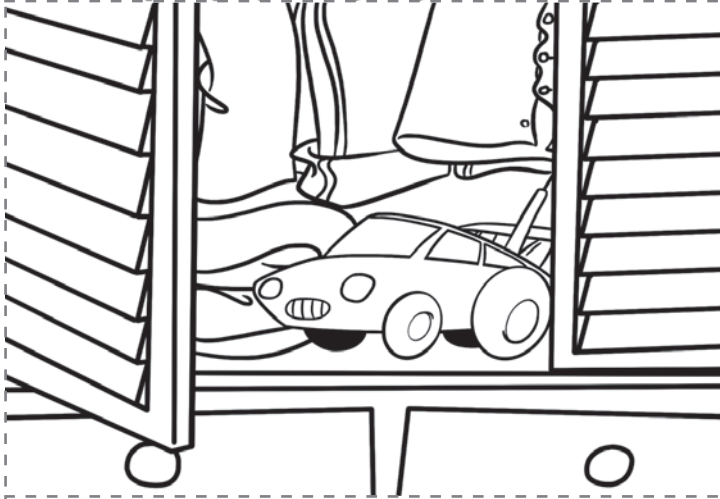
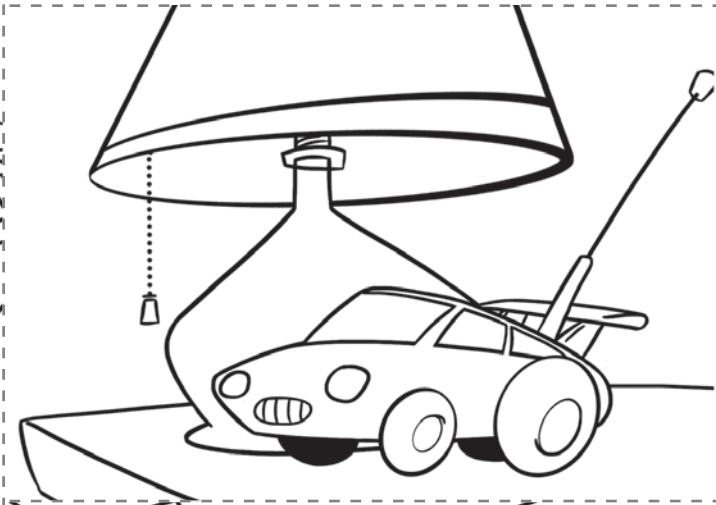
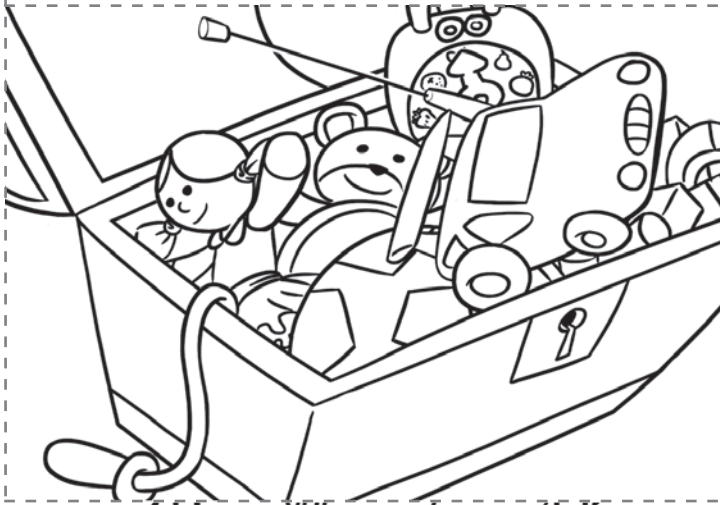

Name:

.....

Name:

.....

Name:

.....

Name:

.....

Name:

.....

Name:

.....

Name:

.....

Name:

.....



Unit 5

14

Cut out and colour. Then listen and play.



CD
2.34

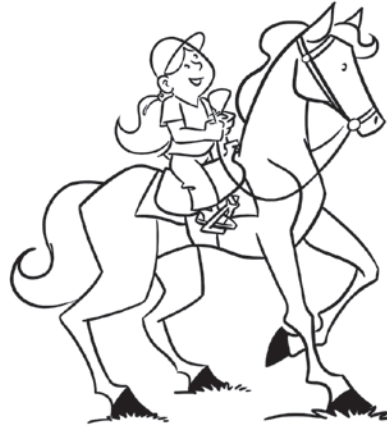

Name:
.....

Name:
.....

Name:
.....

Name:
.....

Name:
.....

Name:
.....

Name:
.....

Name:
.....

Name:
.....



Unit 6

13

Cut out and colour. Then listen and play.



CD
2.50

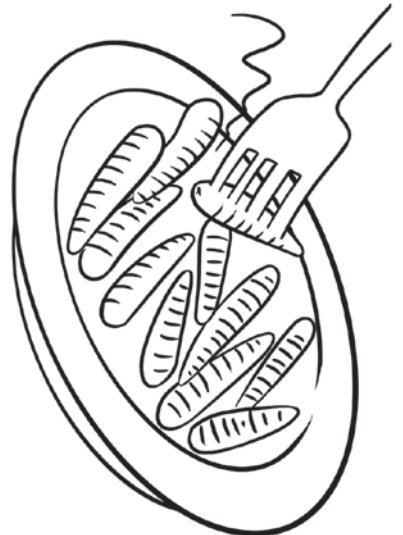
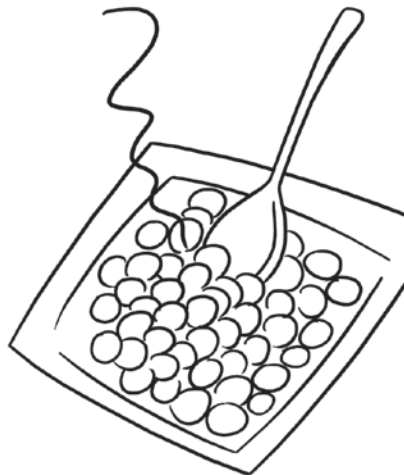
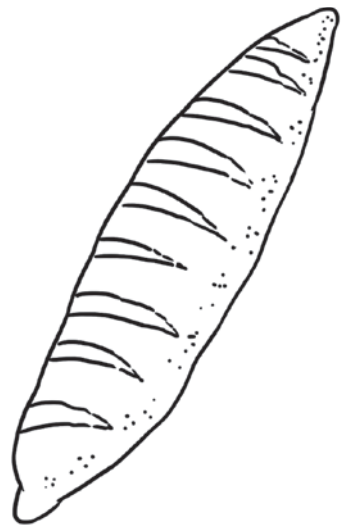
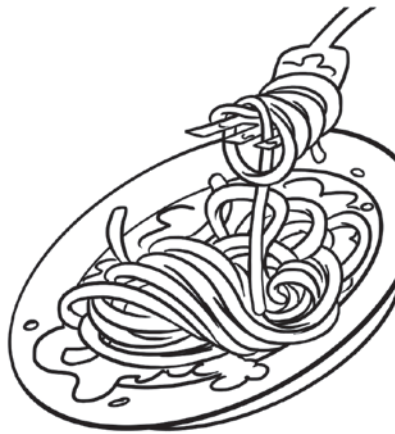
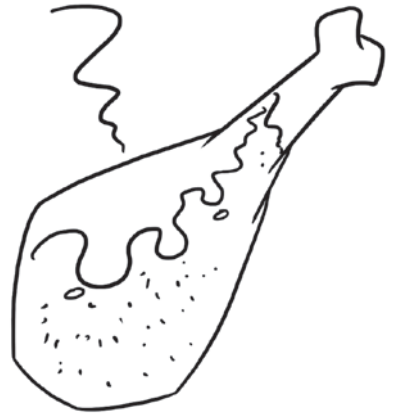

Name:
.....

Name:
.....

Name:
.....

Name:
.....

Name:
.....

Name:
.....

Name:
.....

Name:
.....

Name:
.....



Unit 7

13

Cut out and colour. Then listen and play.



CD
3.15

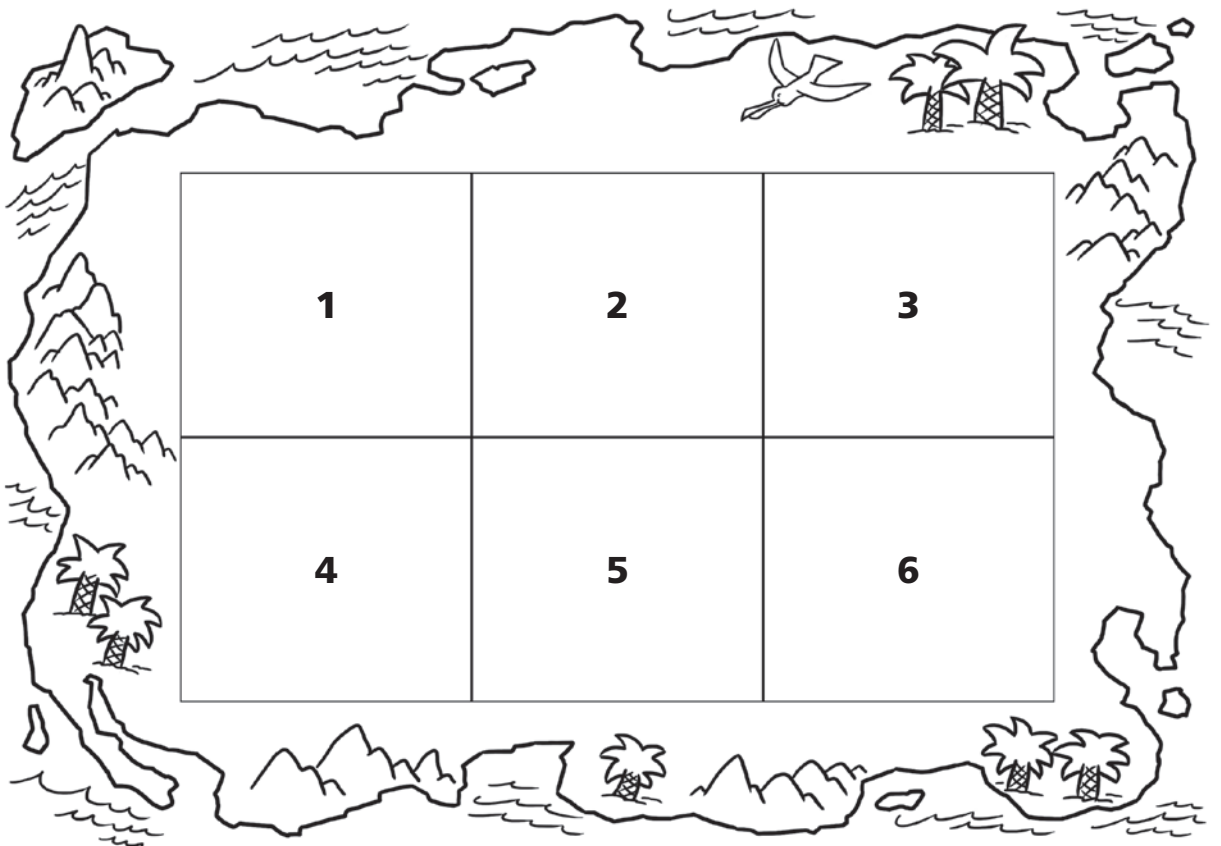
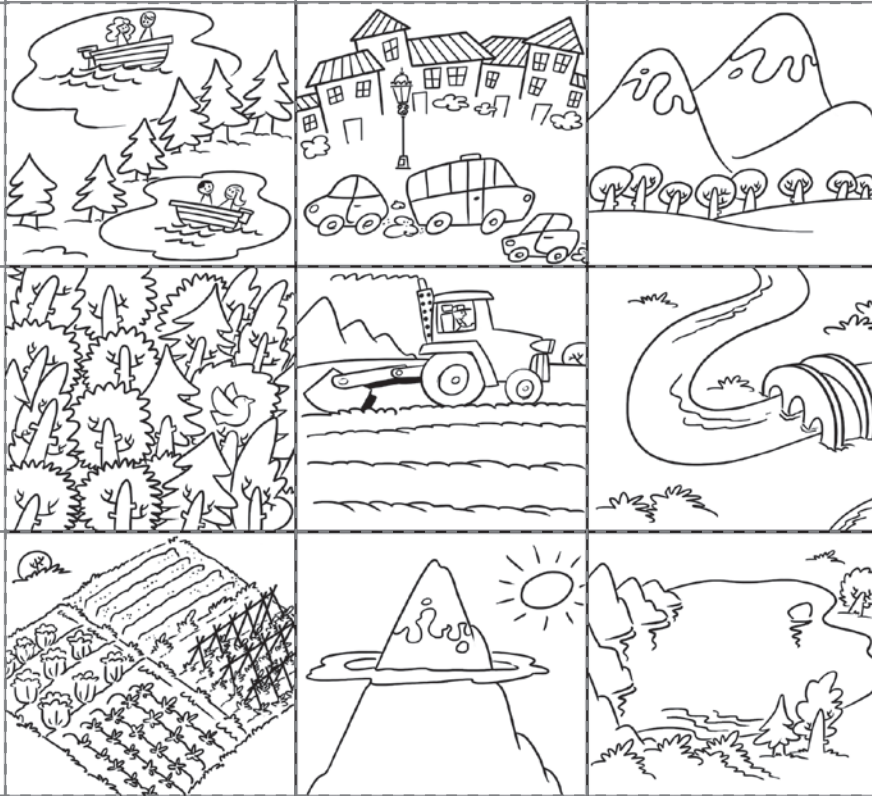

Name:

.....



Unit 8

15

Cut out and colour. Then listen and play.



CD
3.31



Name:
.....

Name:
.....

Name:
.....

Name:
.....

Name:
.....

Name:
.....

Name:
.....

Name:
.....

Name:
.....